



Numeracy lesson plans
Primary 5,
term 2, weeks 11—15

**Decimals, measurements, perimeter
and area of shapes**

**Numeracy lesson plans
Primary 5,
term 2, weeks 11—15
Decimals, measurements, perimeter
and area of shapes**

Introduction

Teaching and learning processes in Kwara State have improved as a result of the introduction of the new lesson plans developed by the State School Improvement Team (SSIT). The recent improvement in the quality of education in Kwara is a direct function of quality teaching.

Evidence of improved teaching quality includes an increase in the number of pupils completing basic education and a general improvement in the levels of literacy and numeracy.

Teachers in Kwara have experienced tremendous professional improvements through training and refresher programmes on the new lesson plans, facilitated by SSIT and school support officers (SSOs).

These lesson plans, designed and edited by Education Sector Support Programme in Nigeria (ESSPIN), have become Kwara teachers' classroom companion.

As teaching manuals, the lesson plans have been designed to provide a step-by-step guide in the teaching of literacy and numeracy. The lesson plans promote more collaborative, interactive, participatory and reflective learning to encourage children to become active learners.

I am sure that continuous use of these lesson plans by teachers will raise the standard of our education in Kwara State and also assist in consolidating the new administration's education reform.

I therefore appreciate the contribution of the UK Department for International Development (DFID), through ESSPIN, in designing, editing and producing the lesson plans.

Alhaji Saka Onimago
Honourable Commissioner
for Education and Human
Capital Development,
Kwara State

Alhaji (Barr) Lanre Daibu
Executive Chairman
Kwara State Universal Basic
Education Board

The numeracy lessons teach calculation, shape, symmetry, fractions and time. Each week focuses on one of these topics.

How

How?

This section illustrates a key concept through simple instructions and photographs. A sign at the top of the column shows you which part of the lesson uses this resource.

Learning expectations

Every pupil in the class will be at a different stage of understanding in maths. The first page of each week outlines learning expectations for the week. These learning expectations are broken into three levels:

What **all** pupils will be able to do.

What **most** pupils will be able to do.

What **some** pupils will be able to do.

Assessment

On each weekly page there is an assessment task for you to carry out with five pupils at the end of the week. This will help you find out whether they have met the learning expectations.

Next to the task, there is an example of a pupil's work, which shows what a pupil can do if they have met the learning expectations.

If most pupils have not met the learning expectations, you may have to teach some of the week again.

Daily practice

Helps the pupils to practise something they have previously learned. It should only last 15 minutes and move at a fairly fast pace.

Introduction

Provides the focus for the lesson. Often involves a variety of fun, quick activities which prepare the pupils for the main topic.

Main activity

Gives the pupils the opportunity to explore the main topic in different ways. This usually involves group, pair or individual tasks. Your role as a teacher during the main activity is to work with groups and individuals to help them to understand the ideas.

Plenary

Finishes the lesson with different ways of reviewing learning.

Grade/
Type of lesson plan

Lesson
title

Weekly page

Primary 5,
numeracy
lesson plans

Week 11:

Numbers

Words/phrases

Write these words on the chalkboard
and leave them there for the week.

backwards
forwards
thousands
ten thousands
digits
greater than
less than

Learning expectations

By the end of the week:

All pupils will be able to:
Multiply whole numbers
by 10 and 100.

Most pupils will be able to:
Identify place value and
expand five-digit numbers.

Some pupils will be able to:
Write any given number
in words and digits.

Assessment task

Instructions:

Ask the individual pupils to complete these tasks in their exercise books.

1

Write down two different five-digit numbers.

2

Write the correct headings (Tth Th H T U) above the numbers.

3

Multiply these numbers by 10: 34, 71

Multiply these numbers by 100: 26, 58

Multiply these numbers by 100: 45, 19

4

Complete and explain the following pattern:

$$3 \times 4 = 12$$

$$30 \times 4 =$$

$$300 \times 4 =$$

$$3000 \times 4 =$$

Example of a pupil's work

This pupil can:

Identify the place value of each digit in a five-digit number.

Multiply whole numbers by 10, 100 and 1000.

Complete a pattern of numbers that increases by $\times 10$, $\times 100$ and $\times 1000$ each time.

Tth Th HTU
2 4 6 1 5

Tth Th HTU
6 7 3 8 4

$$10 \times 34 = 340$$

$$10 \times 71 = 710$$

$$100 \times 26 = 2600$$

$$100 \times 58 = 5800$$

$$1000 \times 45 = 45000$$

$$1000 \times 19 = 19000$$

$$3 \times 4 = 12$$

$$30 \times 4 = 120$$

$$300 \times 4 = 1200$$

$$3000 \times 4 = 12000$$

Week 11: Numbers

Day 1: Place value

Learning outcomes

**By the end of the lesson,
most pupils will be able to:**

Recall the 8 times table
quickly.

Identify the place value
of four-digit numbers.

Preparation

Before the lesson:

Have ready a set of **0—9 number cards**
for each pair.

Copy the **place value chart**, shown opposite,
on to the chalkboard.

Read **How? Guess my number**, as
shown below.

How? Guess my number

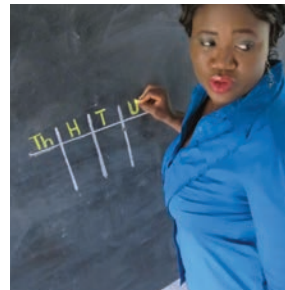

Draw a place
value chart on
the chalkboard.



Choose a pupil to
write a four-digit
number on a piece
of paper and keep
it secret.



Choose some
pupils to say four-
digit numbers
and write them on
the chalkboard.



If any digits match
part of the secret
number, add them
to the chart.



Ask the pupils
to continue until
they guess the
secret number.

10
minutes

Daily practice

Whole class teaching

Ask the pupils to stand in a circle and count forwards in eights, starting at zero (0).

Ask them to count backwards in eights, starting at 96.

Ask some individual pupils questions from the 8 times table.

Ask the following questions:

'If you know what 3×2 is, what is 30×2 ?'

'If you know the answers to 3×2 and 30×2 , what is 300×2 ?'

10
minutes

Introduction

Whole class teaching

Write the following numbers (with the underlined digits) on the chalkboard:

5632
2341
5764
4782
1047

Write, 'Th H T U' on the chalkboard.

Ask, 'What is the place value of each underlined digit?'

Ask the pupils to write the numbers in the correct place value and say the numbers, eg: five thousand six hundred and thirty-two.

25
minutes

0—9 number cards

Chart

Main activity

Pair task

Give each pair a set of 0—9 number cards.

Ask them to put the cards face down.

Tell the pairs to turn over four cards and write all the numbers that they can make with those numbers.

Remind them to say the numbers as they make them.

Ask the pairs to copy the place value chart from the chalkboard into their exercise books.

Tell them to use the following numbers to complete the chart:

1094
3676
4978
8465
6930

Place value chart

	Th	H	T	U	Expand
5632	5	6	3	2	$5000 + 600 + 30 + 2$
1094					

15
minutes

How

Plenary

Whole class teaching

Play **How? Guess my number**, as shown left.

When the pupils have played this several times, they can play in small groups.

Week 11: Numbers

Day 2: Place value to tens of thousands

Learning outcomes

**By the end of the lesson,
most pupils will be able to:**

Recall the 9 times table
quickly.

Identify the place value
of five-digit numbers.

Preparation

Before the lesson:

Copy the [place value chart](#), shown
opposite, on to the chalkboard.

Have ready a set of [0—9 number cards](#)
for each pair.

Read [How? Tens of thousands](#), as
shown below.

How? Tens of thousands



Give a set of 0—9
number cards to
each pair.



Ask them to
choose five cards.



Tell them to make
five-digit numbers
with the cards.



Show the pairs
how to write the
numbers in a place
value chart.



Tell them to write
the chart in their
exercise books
and expand the
numbers.

10
minutes

Daily practice

Whole class teaching

Ask the pupils to stand in a circle and count forwards in nines, starting from 0.

Ask the pupils to count backwards in nines, starting from 108.

Ask individual pupils questions from the 9 times table.

Ask, 'If you know that $3 \times 9 = 27$, what are the answers to the following?'

$30 \times 9 =$
 $300 \times 9 =$
 $30 \times 90 =$
 $300 \times 90 =$

10
minutes

Introduction

Whole class teaching

Remind the pupils that yesterday they identified the place value of four-digit numbers.

Write the following on the chalkboard:
'TTh Th H T U'.

Remind the class that:
Units x Ten = Tens
Tens x Ten = Hundreds
Tens x Hundred = Thousands

Ask, 'What is the next column on the place value chart?' (Tens of Thousands, TTh)

Write, '36426' under the correct place value headings and ask the pupils to say the number, then repeat with:
24548, 38971, 82792.

30
minutes

How

Place value chart

Main activity

Whole class teaching

Teach **How? Tens of thousands**, as shown left.

Use the **chart** below to explain to the class that with the five cards they have chosen they can make many five-digit numbers, eg: 41296, 64921, 91264.

Place value chart

	TTh	Th	H	T	U	Expand
41296	4	1	2	9	6	$40000 + 1000 + 200 + 90 + 6$
64921						
91264						

Remind the pupils to say the numbers they have made to their partner, eg: forty one thousand, two hundred and ninety-six.

Repeat with five new cards.

10
minutes

Game

Plenary

Whole class teaching

Play **guess my number**, as shown in Day 1 (yesterday).

When the pupils have played this several times, they can play in small groups.

Week 11: Numbers

Day 3: Multiplying by 10, 100 and 1000

Learning outcomes

**By the end of the lesson,
most pupils will be able to:**

Understand the pattern
in the 9 times table.

Multiply whole numbers
by 10, 100 and 1000.

Preparation

Before the lesson:

Have ready a set of **0—9 number
cards** for each pair.

Copy the **multiplication calculations**
from today's main activity, shown right,
on to the chalkboard.

Read **How? Multiply by 10, 100, 1000**,
as shown below.

How? Multiply by 10, 100, 1000



Ask the pupils to
choose two number
cards and multiply
the numbers.



Multiply one side
by 10.



Multiply one side
by 100.



Multiply one side
by 1000.



Explain the pattern:
the multiplication
increases by 10, so
does the answer.

10
minutes

Daily practice

Whole class teaching

Explain that the 9 times table can be tricky.

Write the following sums on the chalkboard and ask the pupils to complete the pattern:

$$09 = 9 \times 1$$

$$18 = 9 \times 2$$

$$27 = \square \times \square$$

$$36 = \square \times \square$$

$$45 = 9 \times 5$$

$$54 = \square \times \square$$

$$63 = \square \times \square$$

$$72 = \square \times \square$$

$$81 = \square \times \square$$

$$90 = \square \times \square$$

Look together at the pattern and discuss.

10
minutes

Introduction

Whole class teaching

Remind the pupils of the following:

$$4 \times 6 = 24$$

$$40 \times 6 = 240 \text{ (} \times 10 \text{)}$$

$$400 \times 6 = 2400 \text{ (} \times 100 \text{)}$$

$$4000 \times 6 = 24000 \text{ (} \times 1000 \text{)}$$

Ask, 'What is happening to the answer in each of these sums?'

Explain that when we multiply by Tens, Hundreds or Thousands then the answer will be 10, 100 or 1000 times bigger.

Repeat with:

$$3 \times 9 =$$

$$4 \times 7 =$$

25
minutes

Calculations

Main activity

Individual task

Ask the pupils to complete the following calculations in their exercise books:

$$\square \times 8 = 24$$

$$\square \times 8 = 240$$

$$\square \times 8 = 2400$$

$$\square \times 8 = 24000$$

$$\square \times 9 = 36$$

$$\square \times 9 = 360$$

$$\square \times 9 = 3600$$

$$\square \times 9 = 36000$$

Ask the pupils to complete the patterns for the following sum in their exercise books:

$$\square \times 7 = 21$$

How

0—9 number cards

15
minutes

Game

Plenary

Whole class teaching

Play **multiplication bingo**, as shown in Week 4, Day 2, with the 9 times table.

Whole class teaching

Give each pair a set of **0—9 number cards**.

Teach **How? Multiply by 10, 100, 1000**, as shown left.

Repeat the pattern with two new cards.

Week 11: Numbers

Day 4: Numbers in words and digits

Learning outcomes

**By the end of the lesson,
most pupils will be able to:**

Recall the 7, 8 and 9 times
tables quickly.

Read and write numbers
in words and digits.

Preparation

Before the lesson:

Have ready the [number words chart](#)
used in Week 1, Day 4.

Read [How? Read and write numbers
to 10000](#), as shown below.

How? Read and write numbers to 10000



Display the number
word chart and
choose some
pupils to read the
number words.



Write some five-
digit numbers
on the chalkboard.



Choose some pupils
to write, 'Tth, Th,
H, T, U' in the
correct place above
the numbers.



Choose some pupils
to read the five-
digit numbers
in words on the
chalkboard.



Choose some pupils
to write the correct
numbers to match
the words.

15 minutes | Game

Daily practice

Whole class teaching

Play the [clock times tables](#) game with the 7, 8 and 9 times tables, as shown in Week 3, Day 2.

10 minutes

Introduction

Whole class teaching

Ask the pupils to stand in a circle and count round the circle in 100s and then in 1000s.

Write the following numbers on the chalkboard:

4539

9371

23645

16593

Choose some pupils to read the numbers.

Choose some pupils to write the TTh, Th, H, T and U place values above the numbers.

20 minutes

How

Number words chart

Main activity

Whole class teaching

Look together at the [number words chart](#) from Week 1, Day 4.

Teach [How? Read and write numbers to 10000](#), as shown left.

Individual task

Tell the pupils to write the following numbers in words in their exercise books:

4539

9371

23645

16593

Remind them to use the [number word chart](#).

15 minutes | Game

Plenary

Whole class teaching

Play [guess my number](#), as shown in Week 11, Day 1.

Week 11: Numbers

Day 5: Using $<$ and $>$

Learning outcomes

**By the end of the lesson,
most pupils will be able to:**

Recall the 7, 8 and 9 times
tables quickly.

Use the symbols $<$ and $>$
between four- and five-digit
numbers.

Preparation

Before the lesson:

Have ready a set of **0—9 number
cards** and **$<$ and $>$ cards** for each pair.

Write the **pairs of numbers** from
the main activity, shown right, on
the chalkboard.

Read **How? Less than, greater than,**
as shown below.

How? Less than, greater than



Ask the pupils to read
the numbers and
say them correctly.



Ask, 'Which is
the greater number
in each pair?'
and 'How do you
know that?'



Explain that the
smallest part
of the sign points
to the smallest
number.



Explain that the
largest part
of the sign points
to the largest
number.



Ask the pupils to
hold up the correct
sign to go between
the numbers.

10
minutes

Daily practice

Whole class teaching

Ask the pupils to stand in a circle.

Tell them to count around the circle forwards in nines.

If pupils hesitate for too long or give an incorrect number, they sit down.

Play until only two pupils are left standing.

Repeat with smaller groups and the 7 and 8 times tables.

15
minutes

How

Introduction

Whole class teaching

Write the following on the chalkboard:

2578 3472

98457 23412

Teach **How? Less than, greater than**, as shown left.

25
minutes

Flash cards

Main activity

Whole class teaching

Give out the **< and > cards**.

Write more pairs of numbers on the chalkboard:

4391 6828

56483 34592

90761 90671

Ask the pupils to show the correct symbol to go between the numbers, eg: less than < or greater than >.

Number pairs

Pair task

Ask the pairs to copy the following **pairs of numbers** into their exercise books and put < or > between them:

2344 4763

3462 4504

32395 19467

87367 78364

27930 65841

10
minutes

0—9 number cards/
Flash cards

Plenary

Pair task

Give each pair a set of <, > and **0—9 number cards** and tell them to put the number cards face down.

Tell one pupil in each pair to choose five cards and make a five-digit number.

Their partner should make a five-digit number with the remaining cards.

Tell the pairs to place their < or > card between the numbers.

Tell the pairs to repeat the exercise with other numbers.

Grade/
Type of lesson plan

Lesson
title

Weekly page

Primary 5, numeracy lesson plans

Week 12:

Decimals

Words/phrases

Write these words on the chalkboard
and leave them there for the week.

digits
forwards
backwards
decimals
difference
sum

Learning expectations

By the end of the week:

All pupils will be able to:
Solve simple addition
and subtraction
calculations.

Most pupils will be able to:
Solve addition and sub-
traction calculations
involving decimal numbers.

Some pupils will be able to:
Solve word problems
involving addition
and subtraction.

Assessment task

Example of a pupil's work

Instructions:

Ask individual pupils to complete these tasks in their exercise books.

1

Solve these sums using the vertical method:

$$62.13 + 36.45 =$$

$$46.27 + 21.54 =$$

2

Solve these sums using the vertical method:

$$3.86 - 2.54 =$$

$$9.45 - 4.26 =$$

This pupil can:

Use the vertical method to add four-digit decimal numbers, including carrying hundredths.

Use the vertical method to subtract four-digit decimal numbers, including renaming tenths.

$$62.13 + 36.45 =$$

$$\begin{array}{r} 62.13 \\ + 36.45 \\ \hline 98.58 \end{array}$$

$$46.27 + 21.54 =$$

$$\begin{array}{r} 46.27 \\ + 21.54 \\ \hline 67.81 \end{array}$$

$$3.86 - 2.54 =$$

$$\begin{array}{r} 3.86 \\ - 2.54 \\ \hline 1.32 \end{array}$$

$$9.45 - 4.26 =$$

$$\begin{array}{r} 9.45 \\ - 4.26 \\ \hline 5.19 \end{array}$$

Week 12: Decimals

Day 1: Addition with decimals

Learning outcomes

**By the end of the lesson,
most pupils will be able to:**

Add two-digit
numbers quickly.

Add four-digit
decimal numbers.

Preparation

Before the lesson:

Prepare **20 question sum cards**
involving adding two-digit numbers
(eg: $39 + 13 =$) and **20 answer cards**
(eg: 52).

Copy the **decimal and fraction chart**,
shown opposite, on to the chalk-
board and read **How? Fractions and
decimals**, as shown below.

How? Fractions and decimals



Ask, 'What are the
numbers to the right
of the Units?' (tenths
and hundredths).



Invite some pupils
to change decimals
to fractions (tenths)
on the chalkboard.



Invite some pupils
to help you change
decimals to fractions
(hundredths) on
the chalkboard.



Choose some
pupils to say
decimal numbers,
eg: '346.58'.



Ask a pupil to
identify the value
of each digit.

15 minutes

Addition squares

15 minutes

How

Chart

20 minutes

10 minutes

Game/
Question and answer cards

Daily practice

Introduction

Main activity

Plenary

Whole class teaching

Explain how useful it is to be able to quickly add numbers in your head.

Draw the **addition squares**, shown below, on the chalkboard and tell the pupils to add the numbers across in the first square: (5 + 7, 4 + 9) and down (5 + 4, 7 + 9).

Add the sums together: (12 + 13) (9 + 16) to find the total sum (25).

Look at the second addition square with the pupils.

Addition squares

5	7	
4	9	

8	10	
11	15	

Whole class teaching

Explain to the pupils that we know the place value of whole numbers.

Remind them that fractions and decimals are both part of a whole.

Teach **How? Fractions and decimals**, as shown left, using the **decimal and fraction chart** on the chalkboard.

Ask the pupils to write the following numbers as fractions: 452.6, 34.81

Decimal and fraction chart

	tenths	fraction
1	0.1	$\frac{1}{10}$
2	0.2	$\frac{2}{10}$
10		$\frac{10}{10}$

Pair task

Look together at the following calculation: $13.252 + 4.347 =$

Write the calculation in the vertical form:

$$\begin{array}{r} \text{T U. t h th} \\ 13.252 \\ + 4.347 \\ \hline \end{array}$$

Write the following calculations on the chalkboard and tell the pupils to complete them in their exercise books:
 $11.416 + 0.463 =$
 $6.808 + 53.16 =$
 $7.382 + 0.795 =$

Remind them to write the place values 'T U. t h th' above the calculations.

Whole class teaching

Play **find a friend** using the **question and answer sum cards**.

Week 12: Decimals

Day 2: Addition with decimals

Learning outcomes

**By the end of the lesson,
most pupils will be able to:**

Add two-digit
numbers quickly.

Add four-digit
decimal numbers.

Preparation

Before the lesson:

Have ready the [question and answer cards](#) from Day 1 (yesterday).

Copy the three new [addition squares](#), shown opposite, on to the chalkboard.

Read [How? Decimal addition](#), as shown below.

How? Decimal addition



Look together at the calculation on the chalkboard and ask a pupil to read it.



Write the calculation vertically.



Invite a pupil to calculate the answer and explain each step.

15
minutes

Addition squares

10
minutes

How

25
minutes

10
minutes

Game/
Question and answer cards

Daily practice

Introduction

Main activity

Plenary

Individual task

With the class, look at one of the [addition squares](#) on the chalkboard.

Remind the pupils how to add the numbers across and down to find the total sum.

Give the pupils 5 minutes to complete the squares and find the total sums.

Addition squares

13	10	
25	34	

17	22	
15	33	

19	15	
28	13	

Whole class teaching

Teach [How? Decimal addition](#), as shown left.

Individual task

Ask the pupils to complete the following calculations in their exercise books:

$$9.782 + 8.467 =$$

$$2.765 + 3.218 =$$

$$4.345 + 5.324 =$$

Remind the pupils to write the calculations vertically.

Remind them to write 'U.t h th' place values above the calculations.

Remind them that the rules for crossing boundaries are the same as when adding whole numbers.

Whole class teaching

Play [find a friend](#) using the [question and answer cards](#) from Day 1 (yesterday).

Week 12: Decimals

Day 3: Subtraction with decimals

Learning outcomes

**By the end of the lesson,
most pupils will be able to:**

Add two-digit
numbers quickly.

Subtract four-digit
decimal numbers.

Preparation

Before the lesson:

Write the **calculations** from today's
main activity on the chalkboard.

Copy the six new **addition squares**,
shown opposite, on to the chalkboard.

Read **How? Decimal subtraction**,
as shown below.

How? Decimal subtraction



Look together at
the calculation
on the chalkboard
and ask a pupil
to read it.



Write the calculation
vertically.



Invite a pupil to
write in the place
value above the
numbers.



Invite a pupil to
calculate the
answer and explain
each step.

15
minutes

Addition squares

10
minutes

How

25
minutes

Calculations

10
minutes

Game

Daily practice

Introduction

Main activity

Plenary

Individual task

With the class, look at one of the **addition squares** on the chalkboard.

Remind the pupils how to add the numbers across and down to find the total sum.

Give the pupils 10 minutes to complete the squares and find the total sums.

Addition squares

11	25	
42	30	

25	17	
12	33	

41	17	
19	32	

29	12	
15	35	

31	14	
26	45	

22	36	
44	13	

Whole class teaching

Teach **How? Decimal subtraction**, as shown left.

Pair task

Ask the pairs to solve the following **calculations** in their exercise books:

$$5.23 - 3.21 =$$

$$8.469 - 4.253 =$$

$$5.42 - 1.37 =$$

$$7.636 - 3.342 =$$

Remind the pairs to write the calculations vertically.

Remind them to write 'U.t h th' place values above the calculations.

Remind them that the rules crossing boundaries are the same as when subtracting whole numbers.

When most of the pupils have finished, tell the pairs to exchange books with another pair.

Ask one pupil to read out the answers. If the class agrees, they should mark it with a small tick (✓).

Whole class teaching

Play **guess my number**, as shown in Week 11, Day 1.

Week 12: Decimals

Day 4: Subtraction with decimals

Learning outcomes

**By the end of the lesson,
most pupils will be able to:**

Quickly multiply
a two-digit and a three-
digit number.

Subtract four-digit
decimal numbers.

Preparation

Before the lesson:

Prepare the [question cards](#) from
today's daily practice and keep them
for tomorrow.

Have ready [nine counters](#) for
each pair and a [large paper circle](#)
for each group.

Read [How? Multiplication bingo](#),
as shown below.

How? Multiplication bingo



Write answers to
the question
cards on the chalk-
board and give
out the counters.



Ask the pairs to
draw a 3 x 3 grid
and choose nine
numbers from the
chalkboard.



Tell the pairs to
write one number
in each square.



Ask the questions
from the cards. If
pairs have the correct
answer, they
should cover it.



The first pair to
cover all the
numbers in their
grid correctly should
shout, 'Bingo!'.

15
minutes

How

Question cards

10
minutes

20
minutes

Calculations

15
minutes

Circles/
Game

Daily practice

Introduction

Main activity

Plenary

Whole class teaching

Teach **How? Multiplication bingo**, as shown left, using the following **question cards**:

$20 \times 4 =$
 $70 \times 10 =$
 $4 \times 30 =$
 $6 \times 70 =$
 $60 \times 7 =$
 $35 \times 100 =$
 $25 \times 3 =$
 $9 \times 20 =$
 $10 \times 63 =$
 $45 \times 3 =$
 $30 \times 7 =$
 $4 \times 25 =$
 $50 \times 5 =$
 $75 \times 3 =$
 $80 \times 6 =$

Whole class teaching

Write ' $3.746 - 2.251 =$ ' on the chalkboard.

Ask a pupil to work through the calculation, explaining what they are doing as they work out the answer.

Pair task

Write the following **calculations** on the chalkboard and ask the pairs to solve them in their exercise books:
 $4.261 - 3.151 =$
 $6.592 - 3.271 =$
 $2.543 - 3.436 =$

Remind the pairs to write the calculations vertically.

Remind them to write 'U.t h th' place values above the calculations.

Remind the pupils that the rules crossing boundaries are the same as when subtracting whole numbers.

When most of the pupils have finished, tell the pairs to exchange books with another pair.

Ask one pupil to read out the answers. If the class agrees, they should mark it with a small tick (✓).

Group task

Tell the groups to write the following around the outside of their **circles**, like a clock face: 10, 20, 30, 40, 50, 60, 70, 80, 90, 100, 110, 120.

Play **clock times tables**, as shown in Week 3, Day 2, with the 7 times table, working out the answers to the sums around the clock, ie: from 7×10 to 7×120 .

Repeat with the 8 and 9 times tables.

Week 12: Decimals

Day 5: Word problems

Learning outcomes

Preparation

**By the end of the lesson,
most pupils will be able to:**

Quickly multiply two-digit
and three-digit numbers.

Solve addition and
subtraction word problems.

Before the lesson:

Write the [answers to the bingo questions](#),
from Week 12, Day 4 (yesterday) on
the chalkboard.

Copy the [word problems](#) from today's
main activity on to the chalkboard.

Read [How? Solving word problems](#),
as shown below.

How? Solving word problems



Read the word
problem and ask
a pupil to under-
line the key words.



To find the number
of children, first
add together
the number of men
and women.



Next, subtract that
answer from
the total population.



Then write the
answer in a sentence.

15 minutes | Game

Daily practice

Whole class teaching

Play **multiplication bingo**, as shown in Week 12, Day 4 (yesterday).

10 minutes | How

Introduction

Whole class teaching

Write the following word problem on the chalkboard: 'The population of a town is 22372. There are 4897 men, 5164 women, and the rest are children. How many children are there?'

Teach **How? Solving word problems**, as shown left.

Remind the pupils that they have to pick out key information to solve word problems.

25 minutes | Word problems

Main activity

Whole class teaching

Work through some other **word problems** together, as a class:

'Mr Aina earned N40600 in January and N46300 in February. His total expenses for the two months were N23700. How much did he have left after paying his expenses?'

'A fruit seller bought 1060 oranges from one market and 2350 from another. He sold 2030 oranges. His sister sold the remaining oranges the next day. How many oranges did his sister sell?'

10 minutes

Plenary

Whole class teaching

Choose some pairs to give their answers and explain how they solved the problem.

Ask the pairs:

'What did you do first?'

'Which numbers did you add together?'

'Which numbers did you subtract?'

Ask the rest of the class if they agree with the answer. If not, go through the method as a class.

Weekly page

Primary 5, numeracy lesson plans

Week 13:

Perimeter and area

Words/phrases

Write these words on the chalkboard
and leave them there for the week.

length
breadth
width
area
distance
around
centimetres
perimeter
right-angled

Learning expectations

By the end of the week:

**All pupils will be
able to:**

Find the perimeter of squares
and rectangles.

**Most pupils will be
able to:**

Find the perimeter
and area of squares
and rectangles.

**Some pupils will be
able to:**

Find the perimeter
and area of compound
shapes.

Assessment task

Example of a pupil's work

Instructions:

Ask the individual pupils to complete these tasks in their exercise books.

1
Find the perimeter of the following rectangle.

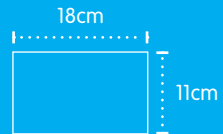

2
Find the area of the following rectangle.

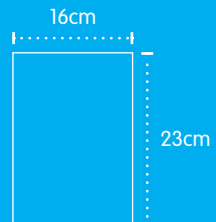

This pupil can:

Find the perimeter of a rectangle.

Find the area of a rectangle.

The student's work is shown in a white box. It includes two problems:

Problem 1: A rectangle with length 18cm and width 11cm. The student calculates the perimeter by doubling each side and adding the results: $18\text{cm} \times 2 = 36\text{cm}$ and $11\text{cm} \times 2 = 22\text{cm}$. These are added together: $36 + 22 = 58$. The final answer is $\text{Perimeter} = 58\text{cm}$.

Problem 2: A rectangle with length 16cm and width 23cm. The student calculates the area by multiplying the length and width: $16\text{cm} \times 23\text{cm} =$. The multiplication is shown in two columns: $\begin{array}{r|l} \times & 10 & 6 \\ \hline 16 & 200 & 120 \\ 3 & 30 & 18 \\ \hline & 200 & 120 \\ & + & 30 \\ & 18 & \\ \hline & 368 & \end{array}$. The final answer is $\text{Area} = 368\text{cm}^2$.

Week 13: Perimeter and area

Day 1: The perimeter of shapes

Learning outcomes

**By the end of the lesson,
most pupils will be able to:**

Find patterns in
multiplication.

Find the perimeter of
squares and rectangles.

Preparation

Before the lesson:

Have ready a 30cm ruler, a card
rectangle or square and a paper circle
for each group.

Copy the chart from today's main
activity on to the chalkboard.

Read [How? Find the perimeter](#),
as shown below.

How? Find the perimeter



Explain that
the 'perimeter' is
the distance
around the outside
of a shape.



Show the pupils how
to measure each
side of the shape
and record the length
and breadth.



Write the formula,
' $l + b \times 2$ ' (length +
breadth $\times 2$).



Invite a pupil to
add $l + b$.



Invite a pupil to
multiply the answer
by 2 to show
the perimeter.

10
minutes

Daily practice

Whole class teaching

Write the following on the chalkboard for the pairs to answer:

$26 \times 1 =$

$26 \times 2 =$

$26 \times 3 =$

$26 \times 4 =$

$26 \times 10 =$

$26 \times 20 =$

$26 \times 30 =$

$26 \times 40 =$

$15 \times 1 =$

$15 \times 2 =$

$15 \times 3 =$

$15 \times 4 =$

$15 \times 10 =$

$15 \times 20 =$

$15 \times 30 =$

$15 \times 40 =$

Ask a pupil to explain the pattern.

15
minutes

How

Introduction

Whole class teaching

Teach **How? Find the perimeter**, as shown left.

Demonstrate with another shape with the following measurements:

$\text{length} = 26\text{cm}$

$\text{breadth} = 18.5\text{cm}$

20
minutes

Rectangles/Squares/
Rulers/Chart

Main activity

Group task

Give each group a **card rectangle or square** and a **ruler**.

Remind the pupils of the formula $\text{perimeter} = \text{length} + \text{breadth} \times 2$ ($p = l + b \times 2$).

Tell the pupils to measure the sides of their shape and record them in their exercise books in a **chart** like the one drawn on the chalkboard.

Perimeter chart

Length	Breadth	Perimeter = $l + b \times 2$

Tell the groups to swap their shape with another group and find the perimeter of their new shape.

Then tell the groups to exchange their answers to see if they agree.

15
minutes

Circles/
Game

Plenary

Group task

Give each group a paper **circle**.

Tell them to write the following around the outside of their circles, like a clock face: 10, 20, 30, 40, 50, 60, 70, 80, 90, 100, 110, 120.

Play **clock times tables**, as in Week 12, Day 4, working out the answers to the 8 times table, from 8×10 to 8×120 .

Repeat with the 4 and 7 times tables.

Week 13: Perimeter and area

Day 2: The area of shapes

Learning outcomes

**By the end of the lesson,
most pupils will be able to:**

Multiply two-digit by
single-digit numbers.

Find the area of
rectangles and squares
using the formula $l \times b$.

Preparation

Before the lesson:

Have ready the [rectangles and squares](#)
from yesterday and a [ruler](#) for each group.

Copy the [chart](#) from today's main
activity and the [word problems](#) from today's
plenary on to the chalkboard.

Read [How? Find the area of a rectangle](#),
as shown below.

How? Find the area of a rectangle



Draw a rectangle on
the chalkboard.



Measure each side of
the shape.
Record the length
and breadth.



The formula for area
is length x breadth
($l \times b$) and the
answer is written
as 45cm^2 .



Look at another
rectangle and invite
a pupil to identify
the calculation.



Invite a pupil to
multiply $l \times b$ to find
the area.

15
minutes

Daily practice

Individual task

Write the following on the chalkboard for the pupils to answer in their exercise books:

$$42 \times 8 =$$

$$25 \times 3 =$$

$$34 \times 7 =$$

$$19 \times 7 =$$

$$53 \times 5 =$$

Choose some pupils to share their answers and explain the method they used to solve the calculations.

If the class agrees, they should mark it with a small tick.

10
minutes

How

Introduction

Whole class teaching

Ask the pupils to discuss their learning from yesterday.

Explain that today they are going to find the area of a shape.

Remind the pupils that area is the measurement of a surface.

Teach **How? Find the area of a rectangle**, as shown left.

Remind the pupils that a square is a special type of rectangle because all of its sides are equal.

25
minutes

Rectangles/Squares/
Rulers/Chart

Main activity

Group task

Give each group a **card rectangle or square** and a **ruler**.

Remind the pupils of the formula $\text{area} = \text{length} \times \text{breadth}$ ($a = l \times b$).

Tell the groups to measure the sides of their shape and record them in their exercise books in a **chart** like the one on the chalkboard.

Area chart

Length	Breadth	Area (cm ²)

Tell the groups to swap their shape with another group and find the area of their new shape.

Then tell the groups to exchange their answers to see if they agree.

10
minutes

Word problems

Plenary

Pair task

Read the following **word problems** with the class and ask the pairs to discuss and find the answers:

'A garden is 8 metres long and 2 metres wide. What is the area of the garden?'

'A playground is 20 metres long and 15 metres wide. What is the area of the playground?'

Choose some pairs to give their answer and explain how they solved the problem.

Week 13: Perimeter and area

Day 3: The area of squares and rectangles

Learning outcomes

**By the end of the lesson,
most pupils will be able to:**

Multiply two-digit numbers
by two-digit numbers.

Find the area of shapes
using the formula $l \times b$.

Preparation

Before the lesson:

Have ready a **ruler** for each pair
and copy the **chart** from today's main
activity on to the chalkboard.

Read **How? Find the area**, as
shown below.

How? Find the area



Draw a rectangle on
the chalkboard
and label the sides
'19cm' and '12cm'.

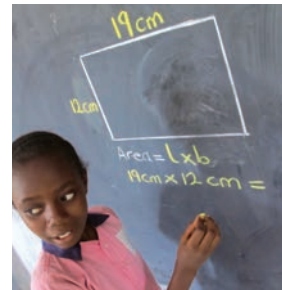

Invite a pupil to
write the formula
to calculate
the area: $l \times b$
(19cm x 12cm).



Invite a pupil to
calculate the answer.



Remind the
pupils to record the
answer in cm^2 .



Look at another
rectangle and invite
a pupil to calculate
the area.

10
minutes

Daily practice

Individual task

Write the following on the chalkboard for the pupils to answer in their exercise books:

$$27 \times 16 =$$
$$36 \times 28 =$$
$$19 \times 32 =$$

Choose some pupils to share their answers and explain the method they used to solve the calculations.

If the class agrees, they should mark it with a small tick.

10
minutes

How

Introduction

Whole class teaching

Draw a rectangle and a square on the chalkboard.

Ask, 'Can anyone say what is special about the sides of a square? (They are the same length.)

Tell the pupils that to find the area of a square we can use the formula $a = l^2$.

Teach **How? Find the area**, as shown left.

25
minutes

Rulers/
Chart

Main activity

Pair task

Ask the pairs to use their **rulers** to measure some rectangular classroom objects and find the area of the objects using the **chart** below.

Area chart

Object	Length	Breadth	Area
exercise book			
textbook			
table			

Remind the pupils that to find the area of a rectangle we use the formula $a = l \times b$.

15
minutes

Plenary

Whole class teaching

Choose some pairs to say their answers and explain how they worked them out.

If the class agrees, they should mark it with a small tick.

Week 13: Perimeter and area

Day 4: The area of compound shapes

Learning outcomes

**By the end of the lesson,
most pupils will be able to:**

Multiply two-digit numbers
by two-digit numbers.

Find the area of
compound shapes.

Preparation

Before the lesson:

Copy the [compound shapes](#)
from today's main activity on to
the chalkboard.

Read [How? Find the area of a compound
shape](#), as shown below.

How?
Find the area
of a compound
shape

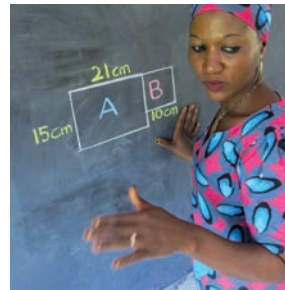

Draw a rectangle
(A) and a square
(B) on the chalkboard
and label the sides.



Write the formula
to calculate the
area for each shape
(l x b).



Invite a pupil to
calculate the answer
for each shape
(A and B).



Add the answers
together to find
the area of the
compound shape.



Remind pupils to
record the answer
in cm².

10
minutes

Daily practice

Individual task

Write the following on the chalkboard for the pupils to answer in their exercise books:

$$34 \times 15 =$$

$$28 \times 32 =$$

$$82 \times 12 =$$

Choose some pupils to share their answers and explain the method they used.

If the class agrees, they should mark it with a small tick.

15
minutes

How

Introduction

Whole class teaching

Teach **How? Find the area of a compound shape**, as shown left.

25
minutes

Compound shapes

Main activity

Pair task

Ask the pairs to find the area of the **compound shapes** on the chalkboard.

Tell them to record the measurements in a chart in their exercise books as they have done earlier this week.

Compound shapes

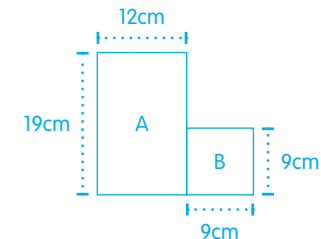
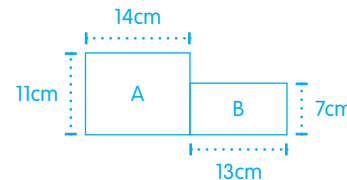
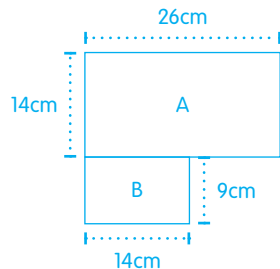

10
minutes

Plenary

Whole class teaching

Choose some pairs to say their answers and explain how they worked them out.

If the class agrees, they should mark it with a small tick.

Week 13: Perimeter and area

Day 5: The perimeter of compound shapes

Learning outcomes

**By the end of the lesson,
most pupils will be able to:**

Recall the 7, 8 and 9 times
tables quickly.

Find the perimeter
of compound shapes.

Preparation

Before the lesson:

Copy the [compound shapes](#)
from today's main activity on to
the chalkboard.

Read [How? Find the perimeter of
a compound shape](#), as shown below.

How? Find the perimeter of a compound shape



Draw a compound
shape (A and B) on
the chalkboard and
label the sides.



To find the perimeter
of a shape we
calculate the total
length around
the outside.



Explain how to work
out the measure-
ments of the
missing length.



Add together
the measurements
to find the total
perimeter.

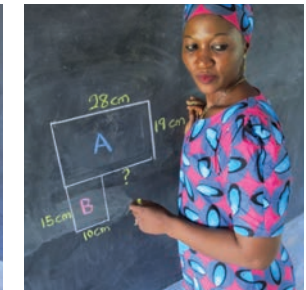

Look at another
compound shape
and calculate the
perimeter together.

10
minutes

Game

Daily practice

Whole class teaching

Play [multiplication bingo](#), as shown in Week 12, Day 4, with the 7, 8 and 9 times tables.

15
minutes

How

Introduction

Whole class teaching

Teach [How? Find the perimeter of a compound shape](#), as shown left.

25
minutes

Compound shapes

Main activity

Pair task

Ask the pairs to find the perimeter of the [compound shapes](#) on the chalkboard and record their measurements in a chart in their exercise books.

Remind the pairs to calculate the perimeter of the shapes carefully.

10
minutes

Plenary

Whole class teaching

Choose some pairs to say their answers and explain how they worked them out.

If the class agrees, they should mark it with a small tick.

Compound shapes

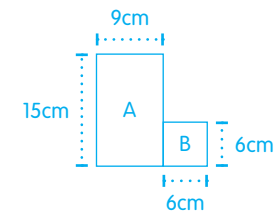
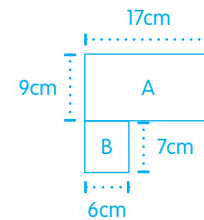
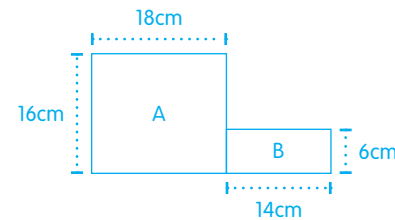

Grade/
Type of lesson plan

Lesson
title

Weekly page

Primary 5, numeracy lesson plans

Week 14:

Shapes and measuring

Words/phrases

Write these words on the chalkboard
and leave them there for the week.

slope
slant
oblique
diagonal
horizontal
vertical
parallel
perpendicular
symmetry
perimeter
intersecting

Learning expectations

By the end of the week:

All pupils will be able to:
Recognise a range of
different lines.

Most pupils will be able to:
Find the perimeter
and area of triangles
and quadrilaterals.

Some pupils will be able to:
Find the perimeter
and area of compound
shapes.

Assessment task

Example of a pupil's work

Instructions:

Ask the individual pupils to complete these tasks in their exercise books.

1
Draw the following lines one at a time, saying which one they are drawing:

vertical
horizontal
oblique
parallel
perpendicular

2
Draw two circles and label the radius on one circle and the diameter on the other circle.

3
Draw a quadrilateral and label, or explain, two of its properties.

This pupil can:

Draw examples of the following lines:
vertical
horizontal
oblique
parallel
perpendicular

Draw and explain the radius and diameter of a circle.

Draw a quadrilateral and label two of its properties.

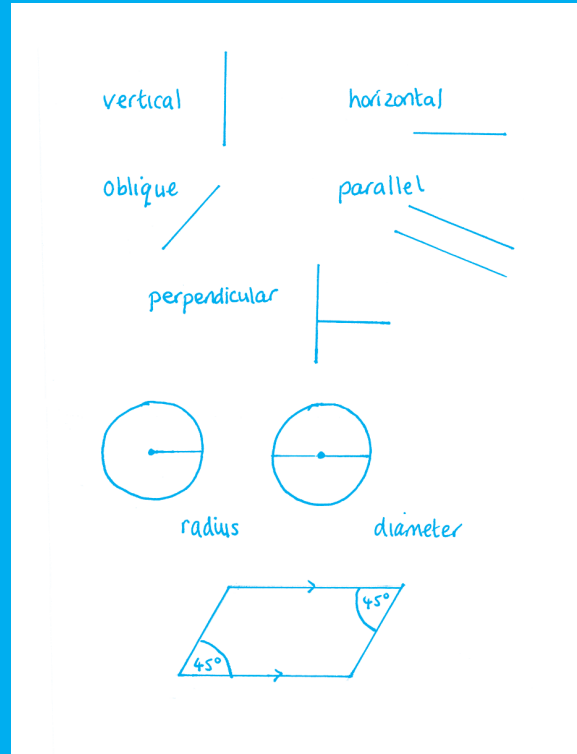

Week 14: Shapes and measuring

Day 1: Lines and triangles

Learning outcomes

**By the end of the lesson,
most pupils will be able to:**

Position the hands
on a clock to make o'clock,
half past, quarter past
and quarter to.

Recognise different types
of lines.

Preparation

Before the lesson:

Draw a large circle on the chalk-
board for each group.

Have **ready two long pieces
of string or rope** for each group.

Read **How? Recognising lines**, as
shown below.

How? Recognising lines

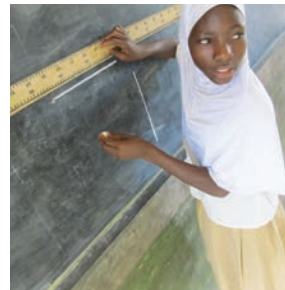

Invite some pupils
to the chalkboard
to draw a horizontal
and vertical line.



'Parallel lines' are
lines side by side,
always the same
distance apart.



'Perpendicular lines'
cross or meet
(intersect) to make
a right angle
(90°).



'Oblique lines'
slant – they are
not horizontal or
vertical.



Remind the pupils
that 'diagonal lines'
are drawn from
one corner to another
inside a shape.

15
minutes

Daily practice

Whole class teaching

Divide the pupils into small groups, lined up in front of a circle on the chalkboard.

Tell the pupils they will make their circles into clocks.

The first pupil from each group should write 1—6 in the correct place on their clock face and the second pupil should write 7—12.

The third pupil should draw the hour hand on o'clock. The fourth pupil should make the clock show 9 o'clock.

Ask other pupils to set the clock hands at other times, eg: half past 8, quarter to 8.

10
minutes

How

Introduction

Whole class teaching

Teach **How? Recognising lines**, as shown left.

25
minutes

String/
Rope

Main activity

Group task

Ask the pupils to get into groups of four or five and give each group **two long pieces of string or rope**.

Call out a type of line, eg: parallel or horizontal, and ask the groups to show the lines.

Then ask the pupils to use the string or rope to make a triangle, a rectangle and a rhombus.

Ask, 'How many lines are parallel?', 'How many lines are perpendicular?'

10
minutes

Plenary

Whole class teaching

Draw the flag of Nigeria on the chalkboard, including the measurements shown below.

Make sure that each part of the flag is the same.

Ask:

'How many pairs of parallel lines are there?'

'How many perpendicular lines are there?'

Nigerian flag

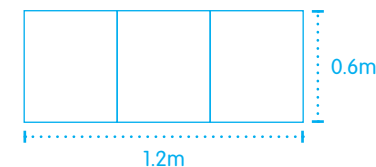

Week 14: Shapes and measuring

Day 2: Triangles

Learning outcomes

**By the end of the lesson,
most pupils will be able to:**

Convert hours to
minutes, minutes to hours
and minutes to seconds.

Recognise different types
of triangles and know some
of their properties.

Preparation

Before the lesson:

Have ready a set of [card triangles](#)
(equilateral, isosceles, scalene, right-
angled) for each group.

Have ready a [clock or watch](#) with
a second hand.

Read [How? Properties of triangles](#),
as shown below.

How? Properties of triangles

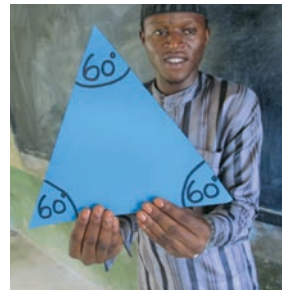

Explain that an
equilateral triangle
has three sides
of the same length.
All angles are 60° .



An isosceles triangle
has two sides of
the same length
and two angles that
are equal.



A scalene triangle
has no sides of
the same length,
and all three angles
are different.



A right-angled
triangle has
one angle of 90° .



Angles can be
'obtuse' (more
than 90°) or 'acute'
(less than 90°).

10
minutes

Daily practice

Group task

Ask the groups to discuss the following questions.

If 1 hour = 60 minutes, how many hours are in:
120 minutes?
360 minutes?
150 minutes?
75 minutes?

How many minutes are in:
1 hour and 20 minutes?
3 hours and 40 minutes?
5 hours and 30 minutes?
12 hours?

If 1 minute = 60 seconds, how many seconds are in:
3 minutes?
5 minutes?
2 $\frac{1}{2}$ minutes?

15
minutes

How

Card triangles

Introduction

Whole class teaching

Ask the class, 'Can you name any triangles?'

Teach **How? Properties of triangles**, as shown left.

Ask, 'What else do you know about these triangles?'

Give each group of pupils a set of **card triangles**.

Choose some groups to name one of their triangles and say something about it.

25
minutes

Main activity

Individual task

Tell the pupils to draw and label an equilateral, isosceles, scalene and right-angled triangle in their exercise books.

Tell them to write at least one property of each shape.

Shape

Pair task

Copy the **counting triangles shape**, shown below, on to the chalkboard.

Ask the class, 'How many triangles can you find?'

Tell the pupils to discuss in pairs.

Ask, 'How many did you find?' (There are 13 triangles altogether.)

Counting triangles shape

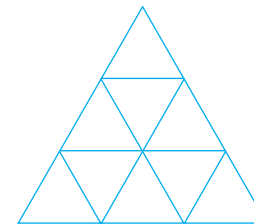

10
minutes

Clock/
Watch

Plenary

Whole class teaching

Explain to the pupils that they are going to estimate time.

Ask them to:

'Put up your hand for 30 seconds.'

'Stand on one leg for 20 seconds.'

'Shake your partner's hand for 10 seconds.'

'Sit perfectly still for 40 seconds.'

Using the **clock** or **watch**, tell the pupils when the time for each activity is up.

Choose some pupils to suggest other actions and timings.

Week 14: Shapes and measuring

Day 3: Quadrilaterals

Learning outcomes

**By the end of the lesson,
most pupils will be able to:**

Sort daily activities
into a morning, afternoon
and evening table.

Name a range of
quadrilaterals and explain
their properties.

Preparation

Before the lesson:

Have ready a set of [card quadrilaterals](#)
(square, rectangle, rhombus,
parallelogram, trapezium).

Copy the [daily activities table](#) from
today's daily practice, shown opposite,
on to the chalkboard.

Read [How? Properties of quadrilaterals](#),
as shown below.

How? Properties of quadrilaterals



Invite a pupil to
draw a square
on the chalkboard
and locate the
right angles.



Invite a pupil
to draw a rectangle
and locate one
pair of parallel lines.



Invite a pupil to
draw a rhombus
and locate one pair
of parallel lines.



Invite a pupil to
draw a parallelogram
and locate one
pair of parallel lines.



Invite a pupil to draw
a trapezium. Ask,
'Does it have parallel
lines and right
angles?' (Yes.)

10 minutes | Table

15 minutes | **How** | Card quadrilaterals

25 minutes | Chart

10 minutes | Shape

Daily practice

Whole class teaching

Ask the pupils to copy the **table** on the chalkboard into their exercise books.

Ask them to write the following activities in the correct part of their table: breakfast, lunch, dinner, play football, go to the market, play with friends, sleep, watch TV.

Choose some pupils to share what they have written.

Daily activities table

Morning	Afternoon	Evening

Introduction

Whole class teaching

Ask the pupils, 'Can you name any quadrilaterals?'

Teach **How? Properties of quadrilaterals**, as shown left.

Give each group of pupils a **card quadrilateral**.

Choose some groups to name the quadrilateral they have and say some of its properties.

Main activity

Individual task

Copy the **2D shapes chart**, shown right, on to the chalkboard. Tell the pupils to copy and label the shapes.





Tell them to write at least one property for each shape.

Group task

Ask the pupils to draw a picture using as many quadrilateral shapes as possible.

Choose some groups to show their pictures and name the shapes that they used.

2D shapes chart

Shape	Name
	Square
	Rectangle
	Rhombus
	Parallelogram
	Trapezium

Plenary

Whole class teaching

Copy the **counting squares shape**, shown below, on to the chalkboard.

Ask the class, 'How many squares can you find?'

Tell the pupils to discuss in pairs.

Ask, 'How many did you find?' (There are 30 squares in this diagram.)

Counting squares shape

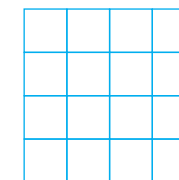

Week 14: Shapes and measuring

Day 4: Circles

Learning outcomes

By the end of the lesson, most pupils will be able to:

Extract information from a timetable.

Recognise the radius, diameter and circumference of a circle.

Preparation

Before the lesson:

Have ready a **ruler** for each pair and all of the **card shapes** used this week.

Copy the **properties of circles**, shown right, on to the chalkboard.

Read **How? Reading a timetable**, as shown below.

How? Reading a timetable



Divide the pupils into groups for a quiz, and give each group a piece of paper.



Tell the groups to discuss time-table information and be ready to answer questions.



Ask, 'How many assemblies are there each week?'



Tell the groups to write their answer on their paper.



The winner is the group with the highest score.

15 minutes

How

Paper

Daily practice

Group task

Explain to the pupils that they are going to use the class weekly timetable for a quiz.

Tell them that for each correct answer their group will win five points, and the group with the most points wins.

Teach **How? Reading a timetable**, as shown left.

Make up other questions to ask the groups, eg: What time is lunch?, What day is double maths?, How long is the English lesson on Monday?'

10 minutes

Properties of circles

Introduction

Whole class teaching

Look with the pupils at the **properties of circles** on the chalkboard.

Explain that the distance around the outside of a circle is called the 'circumference'.

Explain that the 'radius' is the distance from the centre to any point on the circumference.

Explain that the 'diameter' is the distance across the circle, passing through the centre.

Explain that the diameter of a circle is always 2 x the radius.

20 minutes

String/
Rulers

Main activity

Individual task

Tell the pupils to draw and label the circles on the chalkboard in their exercise books.

Tell them to take care to draw the radius and diameter inside their circles.

15 minutes

Shapes

Plenary

Group task

Ask the pupils to sit in small groups.

Share all the **card shapes** you have used this week equally among the groups.

Tell the groups to use all of their shapes to make a design.

Choose some groups to explain the shapes they used in their design.

The diagrams below show the various **properties of circles**:

Centre of circle

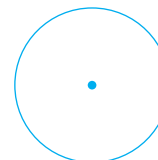

Radius of circle (r) = 2cm

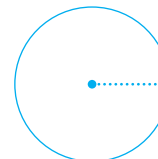

Diameter of circle (d) = 4cm

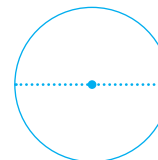

Week 14: Shapes and measuring

Day 5: Perimeter of compound shapes

Learning outcomes

**By the end of the lesson,
most pupils will be able to:**

Calculate the time difference
between Nigeria and
some major world cities.

Calculate the perimeter
of compound shapes.

Preparation

Before the lesson:

Draw the **compound shape**, in
the main activity, shown opposite,
on the chalkboard.

Have ready a **world map** or a **globe**
and draw the **world time chart**, shown
opposite, on to the chalkboard.

Read **How? Perimeter of compound
shapes**, as shown below.

How? Perimeter of compound shapes



Draw a compound
shape on the
chalkboard.



Find the missing
measurements.



Add all the outside
measurements to
find the perimeter
of the shape.



Repeat with
a different
compound shape.

10 minutes

Map/Globe/
Chart

Daily practice

Whole class teaching

Show the pupils the [world map](#) or [globe](#).

Ask, 'Do you think it is the same time all over the world?'

Ask the pupils to explain their answers.

Explain that there are different time zones across the world, and look together at the [world time chart](#) on the chalkboard.

Ask the pupils, 'If it is 11am in Abuja, what is the time in Paris, London and New York?'

Ask other questions about the chart, eg: 'How many hours difference between Abuja and Hong Kong?'

World time chart

Place	Time
Abuja: Nigeria	11am
Beijing: China	6pm
Paris: France	11am
Washington DC: United States of America	6am
Hong Kong: China	6pm
New Delhi: India	3.30pm
Baghdad: Iraq	1pm
London: United Kingdom	10am

10 minutes

How

Introduction

Whole class teaching

Teach [How? Perimeter of compound shapes](#), as shown left.

25 minutes

Shape

Main activity

Pair task

Together with the pupils, look at the [compound shape](#) on the chalkboard, and add together the measurements.

Ask the pairs to copy the shape in to their exercise books and find the missing measurements.

Ask them to decide how they will divide the shape to find the area.

Compound shape

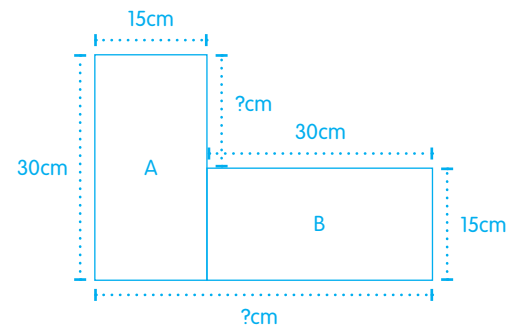

15 minutes

Plenary

Whole class teaching

When most of the pupils have finished, tell the pairs to exchange books.

Ask one pupil to read out their answer. If the class agrees, they should mark it with a small tick.

Grade/
Type of lesson plan

Lesson
title

Weekly page

Primary 5,
numeracy
lesson plans

Week 15:

Multiplication

Words/phrases

Write these words on the chalkboard
and leave them there for the week.

factors
multiply
decimal
grid method
vertical method

Learning expectations

By the end of the week:

**All pupils will be
able to:**

Multiply a decimal number
with a single-digit number.

**Most pupils will be
able to:**

Multiply a decimal number
with a two-digit number.

**Some pupils will be
able to:**

Solve word problems
using multiplication.

Assessment task

Example of a pupil's work

Instructions:

Ask the individual pupils to complete these tasks in their exercise books.

1

Multiply these numbers using the grid method:

$$65.2 \times 6 =$$

$$34.7 \times 22 =$$

2

Multiply these numbers using the vertical method:

$$51.2 \times 4 =$$

This pupil can:

Multiply a decimal number by a single-digit number using the grid method.

Multiply a decimal number by a two-digit number using the grid method.

Multiply a decimal number by a single-digit number using the vertical method.

$$65.2 \times 6 =$$

$$\begin{array}{r|l|l|l} \times & 60 & 5 & 0.2 \\ \hline 6 & 360 & 30 & 1.2 \end{array}$$

$$\begin{array}{r} 360 \\ + 30 \\ \hline 1.2 \\ \hline 391.2 \end{array}$$

$$34.7 \times 22 =$$

$$\begin{array}{r|l|l|l} \times & 30 & 4 & 0.7 \\ \hline 20 & 600 & 80 & 14 \\ \hline 2 & 60 & 8 & 1.4 \end{array}$$

$$\begin{array}{r} 680 \\ + 14 \\ + 68 \\ \hline 1.4 \\ \hline 763.4 \\ \hline 11 \end{array}$$

$$51.2 \times 4 =$$

$$\begin{array}{r} 51.2 \\ \times 4 \\ \hline 0.8 \quad (4 \times 0.2) \\ 4.0 \quad (4 \times 1) \\ 200.0 \quad (4 \times 50) \\ \hline 204.8 \end{array}$$

Week 15: Multiplication

Day 1: Multiplication grid method

Learning outcomes

**By the end of the lesson,
most pupils will be able to:**

Find the factors for
a given product.

Multiply decimal numbers
by a two-digit number
using the grid method.

Preparation

Before the lesson:

Copy the [calculations](#) from today's
daily practice and main activity on to
the chalkboard.

Read [How? Multiply decimals: grid
method](#), as shown below.

How? Multiply decimals: grid method



Ask a pupil to read
the calculation
on the chalkboard.



Invite a pupil to write
the calculation in
a multiplication grid.



Choose some
pupils to complete
the grid.



Choose some
pupils to calculate
the answer.

10
minutes

Calculations

Daily practice

Whole class teaching

Remind the class that factors are numbers you can multiply together to get another number, and a product is the answer when two or more numbers are multiplied.

Ask the pupils to discuss the answers to the following **calculations**, in pairs:

$$\square \times \square = 24$$

$$\square \times \square = 48$$

$$\square \times \square = 100$$

$$\square \times \square = 56$$

$$\square \times \square = 18$$

$$\square \times \square = 63$$

$$\square \times \square = 70$$

Choose some pairs to share their answers with the class.

15
minutes

How

Introduction

Whole class teaching

Ask the pupils to expand the following numbers:
28.36
158.34

Teach **How? Multiply decimals: grid method**, as shown left.

Repeat with the following calculation:
 $28.36 \times 12 =$

25
minutes

Main activity

Individual task

Ask the pupils to complete the following calculations in their exercise books using the grid method:

$$42.50 \times 21 =$$

$$63.30 \times 32 =$$

$$28.10 \times 75 =$$

Tell the pupils to discuss how to work out the answers with their partner.

10
minutes

Plenary

Pair task

Give the pupils the following word problem to solve in pairs:
'If a sack of rice weighs 1.65 kg, what would 10 sacks of rice weigh? What would 15 sacks of rice weigh?'

Ask, 'How would you solve these problems?'

Discuss the pupils' answers.

Week 15: Multiplication

Day 2: Multiplying decimals

Learning outcomes

**By the end of the lesson,
most pupils will be able to:**

Find factors of numbers.

Multiply a decimal number
using the grid method.

Preparation

Before the lesson:

Have ready a set of 0—9 number
cards and two decimal point cards
for each pair.

Read [How? Factor bugs](#), as
shown below.

How? Factor bugs



Explain to the pupils
that factor bugs
can help to show
factors of numbers.



Look at the factor
bug for 32.



Invite some pupils to
add the factors.



Check by multiplying
the factors.

10
minutes

How

Daily practice

Whole class teaching

Ask the pupils to discuss what a factor is.

Teach **How? Factor bugs**, as shown left.

Ask the pupils to draw factor bugs in their exercise books to find the factors of 28, 52 and 90.

10
minutes

Introduction

Whole class teaching

Discuss different methods for multiplying decimal numbers.

Demonstrate the following calculation using the grid method:
 $16.42 \times 23 =$

30
minutes

0–9 number cards/
Decimal point cards

Main activity

Pair task

Give each pair a set **0–9 number cards** and two **decimal point cards**.

Tell the pairs to share the number cards equally and take a decimal point card each.

Tell each pupil to make a four-digit number with their cards.

Then tell them to multiply the number they have made with their last digit card and write the answer in their exercise books.

Repeat this exercise three times, choosing new cards each time.

10
minutes

Grid/
Game

Plenary

Whole class teaching

Copy the **grid**, shown right, on to the chalkboard and teach the pupils how to play the **noughts and crosses** game with calculations.

Choose one pupil to be 'O' and another to be 'X'.

Ask them to choose a square and explain that they win the square if they answer the question correctly.

The first person to get three correct answers in a line wins the game.

Play several times, changing the calculations.

Noughts and crosses grid

13×3	40×3	22×6
5×3	6×12	52×3
30×4	3×20	5×12

Week 15: Multiplication

Day 3: Vertical multiplication

Learning outcomes

**By the end of the lesson,
most pupils will be able to:**

Find factors of numbers.

Multiply decimal numbers
using the vertical method.

Preparation

Before the lesson:

Copy the [calculations](#) from today's
introduction and main activity on to
the chalkboard.

Read [How? Decimal multiplication](#),
as shown below.

How? Decimal multiplication



Ask a pupil to read
the calculation
on the chalkboard.



Invite a pupil to
write the calculation
vertically.



Ask a pupil to work
out the next steps.



Remind the pupils
to set out the
numbers in their
correct place value.



Calculate the answer.

10
minutes

Daily practice

Whole class teaching

Ask the pupils to discuss what a factor is.

Look at a factor bug for 42 together.

Ask the pupils to help you complete factor bugs for 80, 120 and 144.

10
minutes

How

Calculations

Introduction

Group task

Look at the following **calculations** on the chalkboard with the pupils:

$$0.2 \times 3 = \square$$

$$0.21 \times 3 = \square$$

$$0.3 \times 2 = \square$$

$$0.32 \times 2 = \square$$

$$0.5 \times 3 = \square$$

$$0.51 \times 3 = \square$$

$$0.6 \times 4 = \square$$

$$0.62 \times 4 = \square$$

Ask the groups to discuss the answers.

Choose some groups to give their answers and explain how they solved the sum.

Teach **How? Decimal multiplication**, as shown left.

Repeat with $45.16 \times 6 =$

30
minutes

Calculations

Main activity

Pair task

Ask the pairs to discuss the following **calculations** and complete them in their exercise books:

$$\begin{array}{r} 32.61 \\ \times \quad 8 \\ \hline \end{array}$$

$$\begin{array}{r} 45.61 \\ \times \quad 8 \\ \hline \end{array}$$

$$\begin{array}{r} 32.34 \\ \times \quad 9 \\ \hline \end{array}$$

$$\begin{array}{r} 65.32 \\ \times \quad 3 \\ \hline \end{array}$$

10
minutes

Plenary

Whole class teaching

When most of the pupils have finished, tell the pairs to exchange books.

Ask one pair to read out their answers. If the class agrees, they should mark it with a small tick.

Explain to the pupils that they have to solve the following calculations quickly:

$$23.67 \times 10 =$$

$$23.67 \times 100 =$$

$$45.98 \times 10 =$$

$$45.98 \times 100 =$$

$$345.59 \times 10 =$$

$$345.59 \times 100 =$$

Choose some pupils to explain how they worked out the answer.

Ask, 'What happens when you multiply decimal numbers by 10?', 'What happens when you multiply decimal numbers by 100?'

Week 15: Multiplication

Day 4: Multiplication

Learning outcomes

Preparation

**By the end of the lesson,
most pupils will be able to:**
Understand prime numbers.
Multiply decimal numbers
by two-digit numbers.

Before the lesson:
Copy the **calculations** from today's main
activity on to the chalkboard.
Read **How? Finding prime numbers**,
as shown below.

How? Finding prime numbers



Draw a Hundred square on the chalkboard or on paper and cross out the number 1.

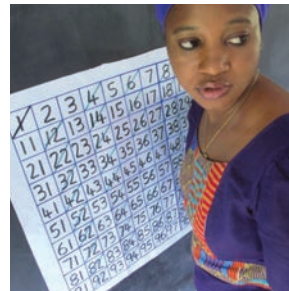

Leave number 2 but cross out all multiples of 2 (even numbers).



Leave the number 3 but cross out all multiples of 3.



Leave the numbers 5 and 7 but cross out all multiples of 5 and 7.



Look at the numbers you have left. They are called 'prime numbers'.

15
minutes

How

Daily practice

Whole class teaching

Explain to the pupils that a 'prime number' has only two factors: itself and the number 1.

Teach **How? Finding prime numbers**, as shown left.

Ask the pupils, 'How many prime numbers are there?' (25)

10
minutes

Introduction

Whole class teaching

Choose some pupils to demonstrate the grid method and vertical method with the following calculations – let them choose which method to use:

$$62.36 \times 15 =$$
$$342.7 \times 6 =$$

25
minutes

Calculations

Main activity

Pair task

Ask the pairs to complete the following **calculations** in their exercise books, choosing the method they want for each calculation:

$$9.66 \times 8 =$$

$$3.19 \times 23 =$$

$$14.62 \times 37 =$$

$$35.45 \times 16 =$$

$$21.94 \times 11 =$$

10
minutes

Plenary

Group task

Ask the groups to find the factors of the following numbers: 28, 42 and 56.

Choose some groups to share their answers and ask if the class agrees.

Week 15: Multiplication

Day 5: Solving word problems

Learning outcomes

**By the end of the lesson,
most pupils will be able to:**

Identify odd, even and
prime numbers.

Solve multiplication
word problems involving
decimals.

Preparation

Before the lesson:

Copy the [word problems](#) from
today's introduction and main activity
on to the chalkboard.

Have ready a set of [0—9 number
cards](#) for each pair.

Read [How? Odd, even, prime?](#),
as shown below.

How? Odd, even, prime?



Give each pair
0—9 cards and
tell them to keep
them in a pile
between them.



Tell the pupils to
take turns to take
one or two cards.



Tell them to make
a single-digit or
two-digit number.



Tell them to
discuss with their
partner whether
it is an odd, even
or prime number.



Go around and
support the pairs,
discussing the
pupils' thinking.

15
minutes

How

Daily practice

Whole class teaching

Ask the pupils to discuss what a prime number is.

Choose a pupil to explain it to the class.

Teach **How? Odd, even, prime?**, as shown left.

10
minutes

Word problems

Introduction

Whole class teaching

Read the following **word problems** with the pupils and discuss how to work out the answers:

'If an exercise book costs N65.30, what is the cost of 10 exercise books?'

'If 10 exercise books cost N653.00, what is the cost of 20, 30 and 40 exercise books?'

'If each pupil in this class has to have 2 exercise books, what is the total cost?' (Calculate the number of pupils in the class x the cost of 2 exercise books.)

25
minutes

Word problems

Main activity

Pair task

Ask the pairs to discuss and complete the following **word problems**:

'The cost of feeding a boarder at secondary school is N125.50 per meal. If she eats three meals a day, what is the cost per day? If she eats three meals a day for 7 days, what is the cost for a week?'

'A man earns N328.60 per day. How much does he earn in: 7 days, 10 days and 31 days?'

10
minutes

Plenary

Whole class teaching

Remind the pupils that 0.25 is the same as $\frac{1}{4}$

Choose some pupils to work out the answers to the following calculations and explain how they did it:

$$0.25 \times 8 =$$

$$\frac{1}{4} \times 16 =$$

$$0.25 \times 64 =$$

$$0.25 \times 176 =$$

$$\frac{1}{4} \times 36 =$$

Credits

Many different stakeholders have contributed to the development and production of these lesson plans.

Much of the work was done by the Kwara State School Improvement Team.

Special thanks go to

Honourable Commissioner of Education and Human Capital Development (MOEHCD), Alhaji Mohammed Atolagbe Raji, the Executive Chairman of the State Universal Basic Education Board (SUBEB), Alhaji (Barr) Lanre Daibu and their staff for their time and valuable input.

The Teacher Development Division School, MOEHCD, School Improvement Unit, SUBEB and the State School Improvement Team (SSIT) for their contributions.

Thanks also go to all the teachers who have used these plans and started to bring about change in their classrooms.

This document is issued for the party which commissioned it and for specific purposes connected with the captioned project only. It should not be relied upon by any other party or used for any other purpose.

We accept no responsibility for the consequences of this document being relied upon by any other party, or being used for any other purpose, or containing any error or omission which is due to an error or omission in data supplied to us by other parties.

These materials were produced with UKaid technical assistance from DFID under ESSPIN.

Copyright © Cambridge Education Limited 2015.



This publication is not for sale

These literacy lesson plans belong to:



Kwara State Government



Produced with the support of

esspin

Education Sector
Support Programme
in Nigeria



UKaid

from the Department for
International Development